



product manual installation instructions for RVS-3CAM5077N

# REAR VIEW CAMERA SYSTEM ▶



# contents

▶ Introduction .....	03
▶ Safety Information .....	04
▶ Installation Guide .....	06
▶ Features .....	11
▶ Multiplexer Specs .....	12
▶ Positioning .....	13
▶ Monitor Dimensions .....	14
▶ Camera Dimensions .....	15
▶ Camera Specs .....	16
▶ Monitor Specs .....	17
▶ LCD Parametres .....	17
▶ Splitting and Installing the Embedded Monitor.....	18
▶ Troubleshooting .....	19
▶ Warranty.....	20

# introduction

**Please read all of the installation instructions carefully before installing the product. Improper installation will void manufacturer's warranty.**

Congratulations on purchasing a Rear View Backup Camera System. With this manual you will be able to properly install and operate the unit.

The Backup Camera System is intended to be installed as a supplement aid to your standard rear view mirror that already exists in your vehicle. The Backup Camera System should not be used as a substitute for the standard rear view mirror or for any other mirror that exists in your vehicle.

In some jurisdictions, it is unlawful for a person to drive a motor vehicle equipped with a TV viewer or screen located forward of the back of the driver's seat or in any location that is visible, directly or indirectly, to the driver while operating the vehicle.

## **WARNING**

1. To prevent electrical shock, DO NOT OPEN THE MONITOR CASE.
2. Avoid exposing monitor to water, rain, moisture etc. It is NOT water proof. Any moisture inside the monitor could cause extensive damage.
3. Do not disassemble the camera. This voids the warranty. Disassembling the camera will compromise the waterproof seal.

# safety info.

- Place the monitor away from direct sun light, heat, water or moisture. This product is made with precise electronic components. Handle with care. Improper use can cause a malfunction.
- Firmly fix the monitor stand to secure location.
- While installing the Rear View System be careful with the wire positioning in order to avoid wire damage.
- The Rear View System should only be used when the vehicle is in reverse. Do not watch movies or operate the monitor while driving, It may cause an accident.
- Do not install the monitor where it may obstruct drivers view or obstruct an air bag device.
- Do not attempt to service this product on your own. If the system has any problem, disconnect the power and contact customer service.
- Dropping the unit may cause possible mechanical failure.

IN NO EVENT SHALL SELLER OR MANUFACTURER BE LIABLE FOR ANY DIRECT OR CONSEQUENTIAL DAMAGES OF ANY NATURE, OR LOSSES OR EXPENSES RESULTING FROM ANY DEFECTIVE PRODUCT OR THE USE OF ANY PRODUCT.

If you have any questions about this product, please contact our Customer Service:

**RVS Systems**

**1680 Atlantic Ave #301**

**Brooklyn NY 11213**

**888-881-2601**

# before you begin installation

Before drilling please check that no cable or wiring is on the other side of the wall. Please clamp all wires securely to reduce the possibility of them being damaged while vehicle is in use. Keep all cables away from hot or moving parts and electrical noisy components.

**We recommend doing a benchmark test before installation to insure that all components are working properly.**

- ▶ **Step 1** Choose the monitor and camera locations.
- ▶ **Step 2** Install all cables in vehicle, when necessary a 0.8 (20mm) hole should be drilled for passing camera cable through vehicles walls. Install split grommets where applicable
- ▶ **Step 3** Once all cables and wiring have been properly placed routed, perform a system function test by temporarily connecting the system. If the system seems to not be operating properly see troubleshooting

# installation diagram

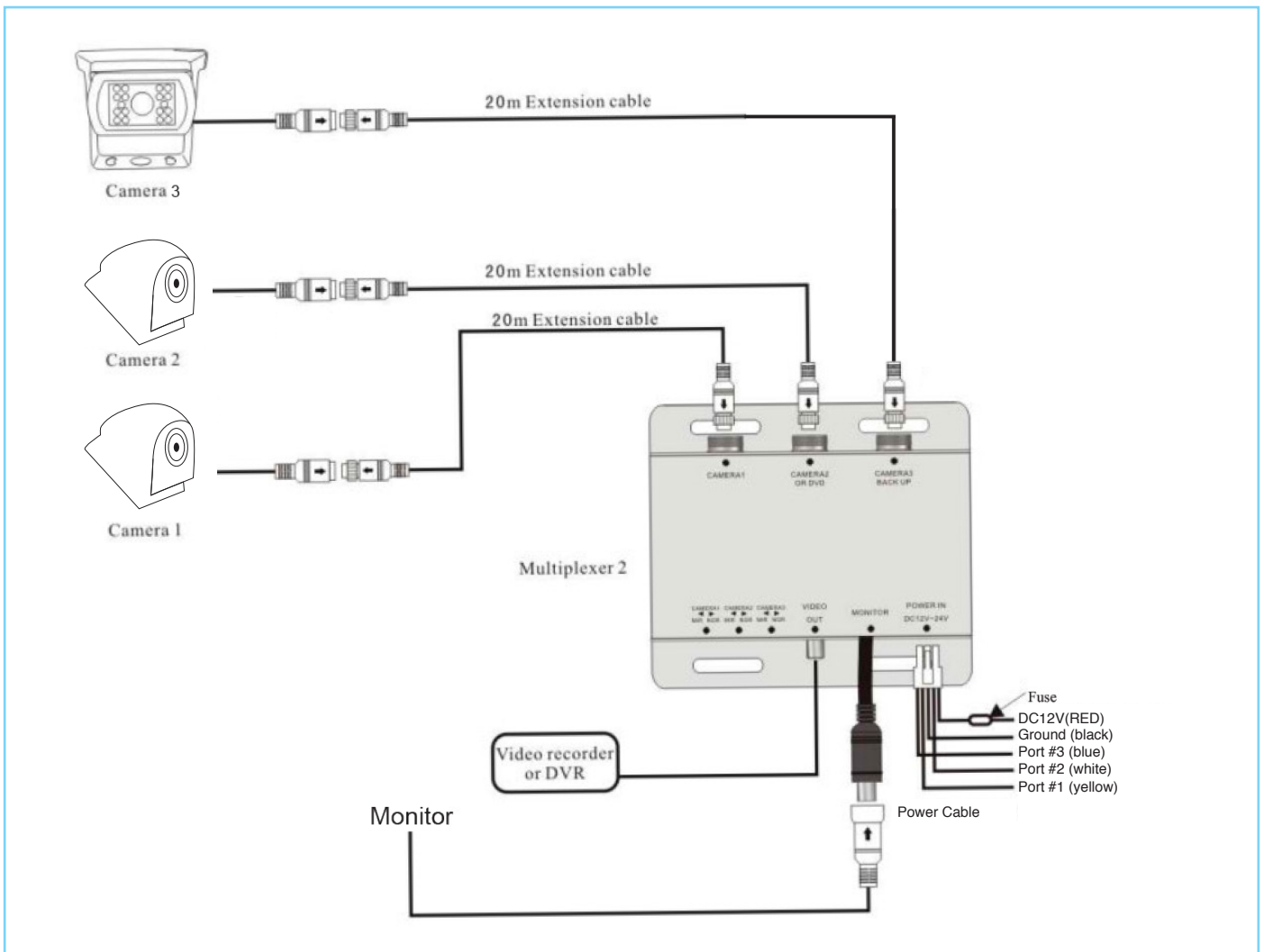

# installation instructions

**Note: THE FOLLOWING INSTRUCTIONS ARE FOR TYPICAL REAR-VIEW APPLICATION.**

## ▶ **Camera**

- 1.** Attach camera bracket close to rear marker lights, centered on vehicle.
- 2.** Attach camera to bracket using screws provided and adjust the angle.

## ▶ **Cable**

- 1.** Be sure to position the cable properly. The aviation camera cable uses aircraft grade connectors which means the camera cable can be exposed to all weather elements, do not run the cable over sharp edges, do not kink the cable and keep away from HOT and rotating parts.
- 2.** Fasten all cable and secure all excess cable.

## ▶ **Monitor**

- 1.** To Attach the Pedestal mount to the dashboard or to the headliner using self-tapping screws and/or adhesive pad.
- 2.** Attach monitor to mount, and adjust mounting angle to allow optimum driver viewing comfort. *(see figure 1.1 on page 8)*

# installing of the monitor

## On Select Models

Figure 1.1

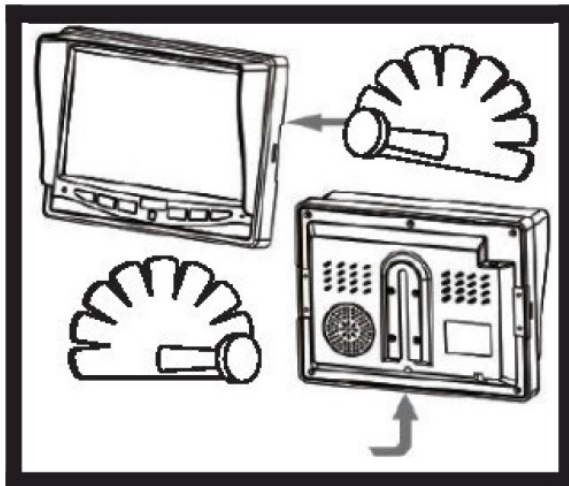

Figure 1.2

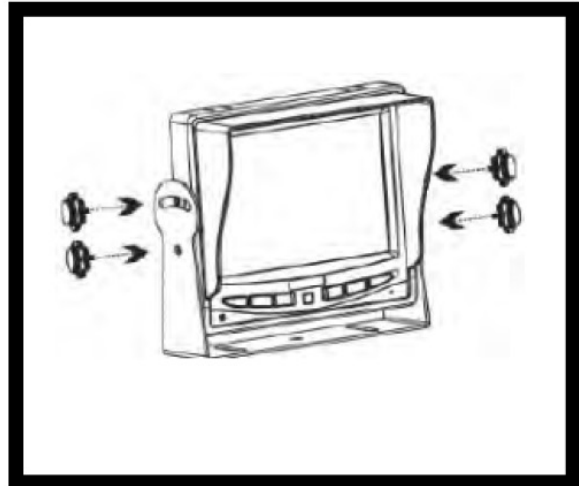
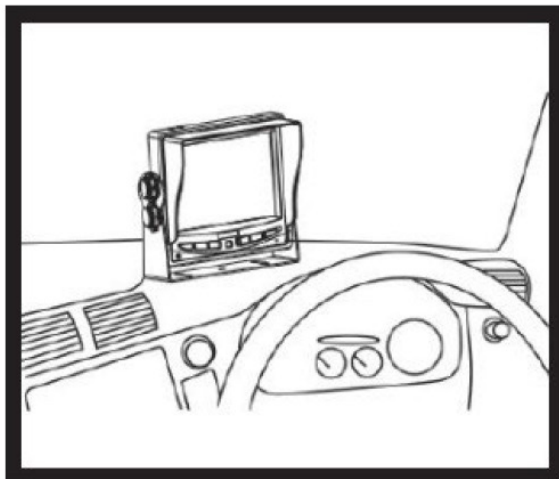
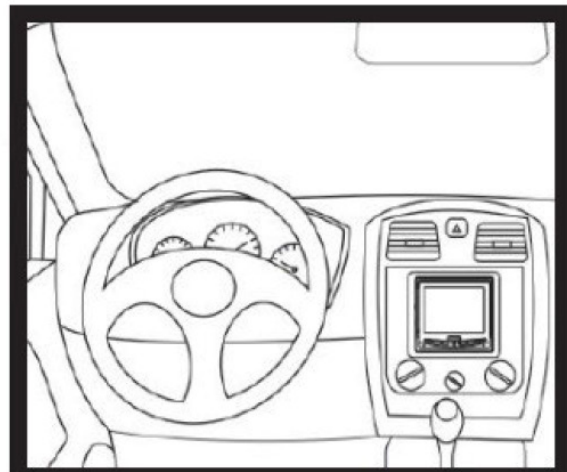

Figure 1.3



Connection of U Bracket

Figure 1.4



Connection of Flushmount Bracket



# wiring camera & monitor

- When installing a **ONE (1)** camera setup, connect camera extension cable from the rear view camera to port # labeled “backup” (most systems port #3) Connect red 12V+ wire to ignition power source and black wire 12V- to chassis ground. Do not use white and yellow wires.
- The blue wire is the REVERSE trigger wire. In typical rear-view installations, connecting this wire to the vehicle’s backup light circuit will activate the rear-view image whenever the vehicle shifts into reverse.
- Before drilling, be sure no cable or wire is on the other side.
- Feed as much cable as possible into vehicle and clamp securely. This reduces the possibility of cable being hooked or snagged.
- Camera: Drill a 20mm (0.8in) diameter hole into vehicle body near the camera and bracket. Insert camera cable into vehicle (be careful not to kink cable) and fit grommet into hole. Apply sealant around grommet to increase resistance to water penetration. Connect camera to the camera extension cable which runs inside the vehicle.
- The camera system can be wired to be powered “ON” the entire time the vehicle is activated and this is typical in RV and some Commercial applications.
- The camera and monitor can always be activated by manually pushing the power button on monitor this is in addition to utilizing the positive triggers.

**Note: IF CONNECTING POWER DIRECTLY TO BATTERY, THE CAMERA IS ALWAYS ON AND THEREFOR CAN DRAIN BATTERY, THEREFORE ITS RECOMMENDED TO CONNECT POWER TO AN IGNITION SWITCHED ACCESSORY POWER SOURCE.**

# installation

- Audio works on two ports of multiplexer and positive triggers must be triggered for audio to operate. (3) Port labeled “backup” (blue trigger)  
(2) port labeled “DVD” (white Trigger)
- When installing a **TWO (2)** camera setup, use ports #3 and #2 and use positive triggers Blue and White
- There is a built in voltage regulator for our systems which can handle 12-24 volts real consumption is 10 to 30 Volts
- When installing all **THREE (3)** cameras, use all three ports and connect all positive triggers to appropriate connections.



To automatically have camera and monitor turn ON when vehicle activates, simply twist BLUE positive trigger 12V+ to Red Power line 12V+ and wire to ignition power which can be an accessory switch/fuse line and black wire 12V- to chasis ground.



Infra-red technology built into camera IR's are activated automatically according to the lighting conditions



When using the positive trigger functions (blue, yellow and white wires) each trigger function needs to work on a separate 12V+ source i.e. the Yellow and White wires can be wired to a turn signal circuit etc.



Grid lines function can be turned on/off by pushing menu 8 times and then select ON/OFF

# camera diagram

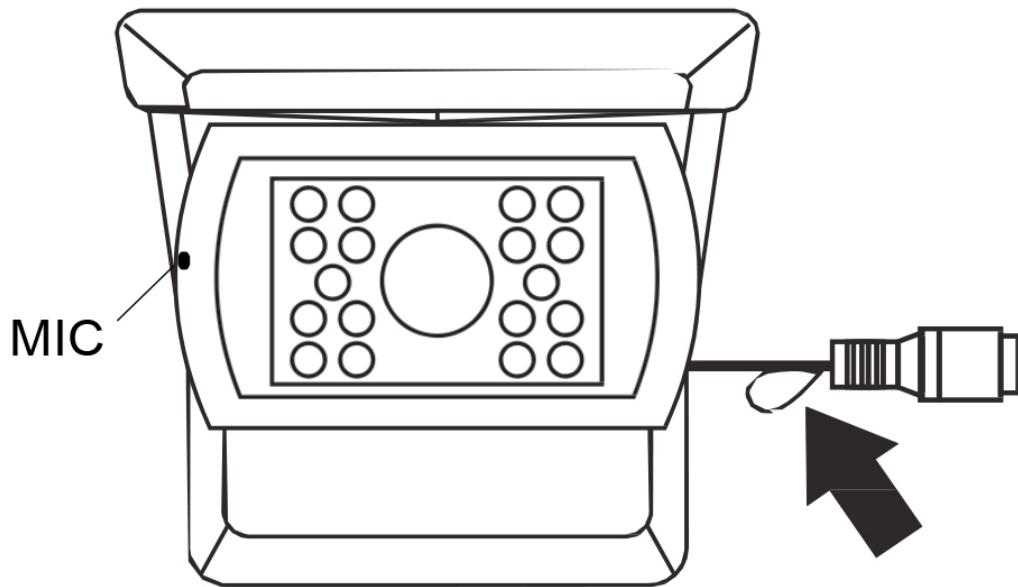

In some models, to remove gridlines from camera, cut green wire

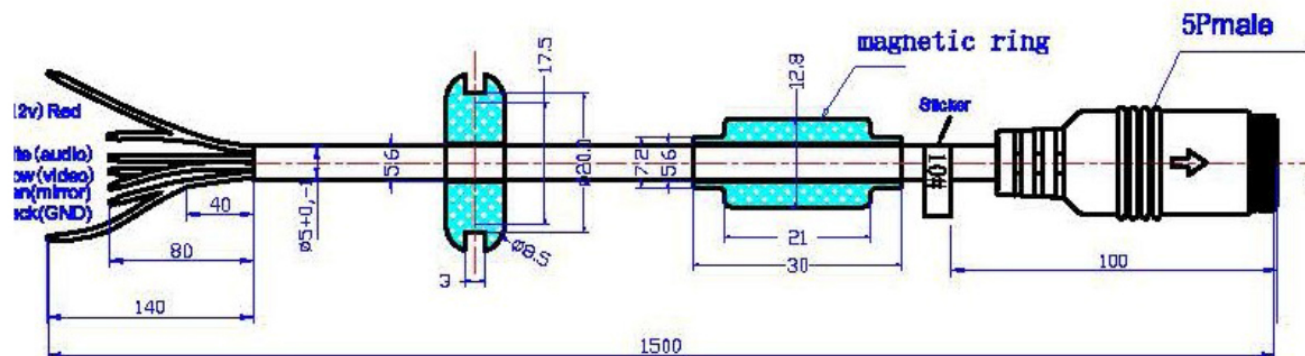
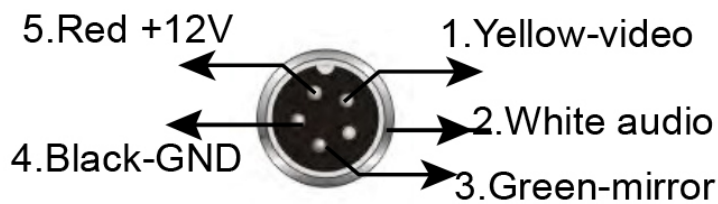

# multiplexer

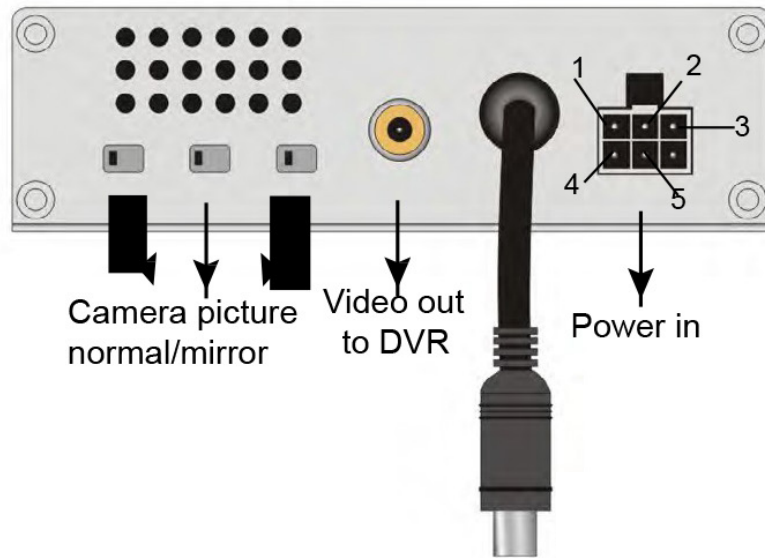

Pin Number	Description
1	Blue: Reverse Gear Power circuit port #3
2	Yellow: Camera - Port #1
3	Red: DC12-24V power input
4	White: Camera Port #2
5	Black: Ground

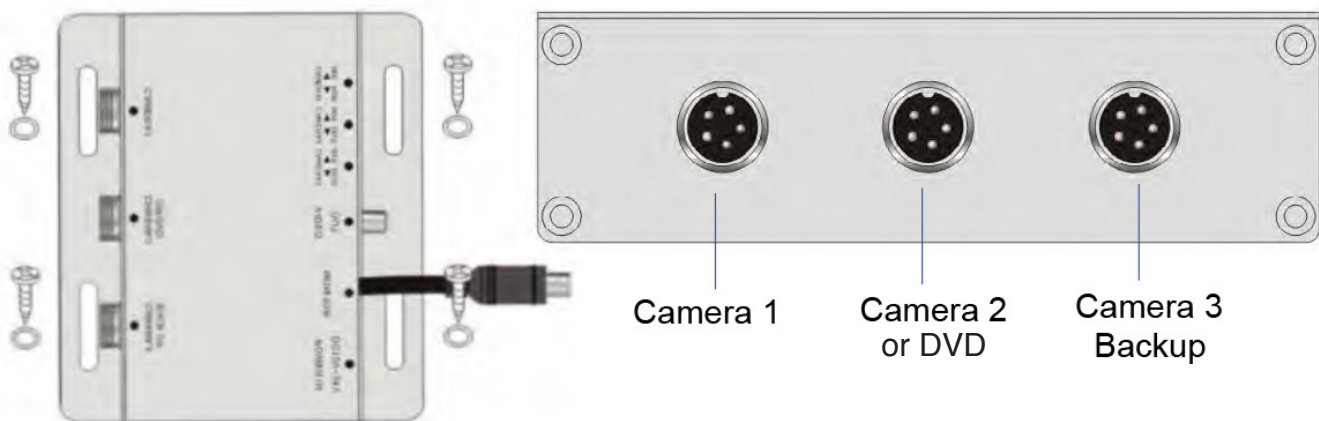

# positioning

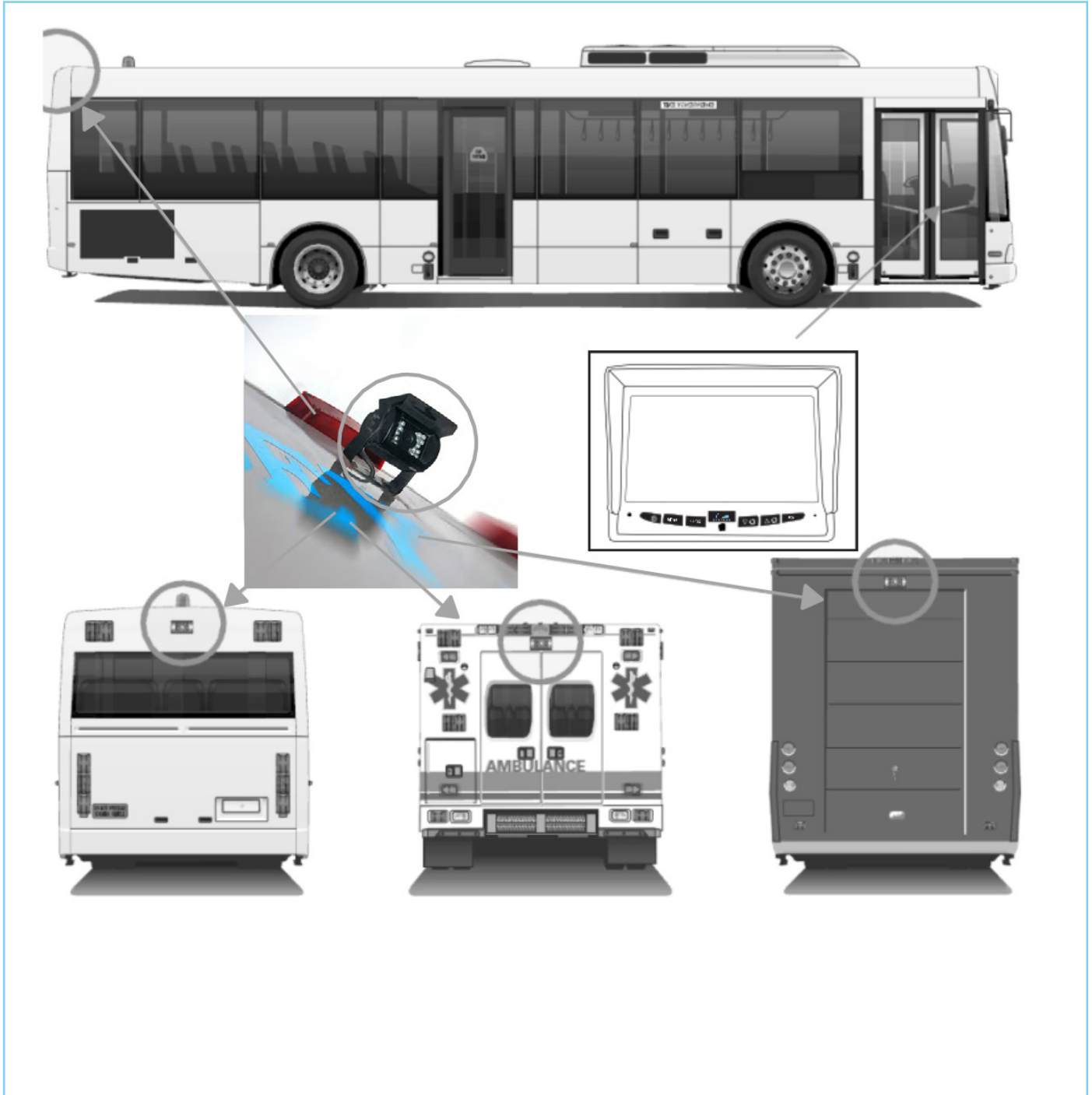

# monitor dimensions

## Some Models

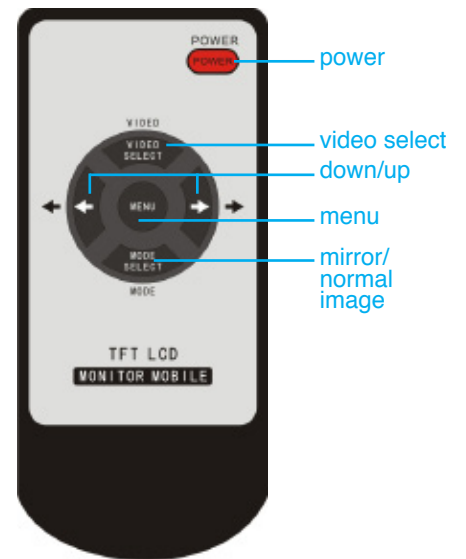
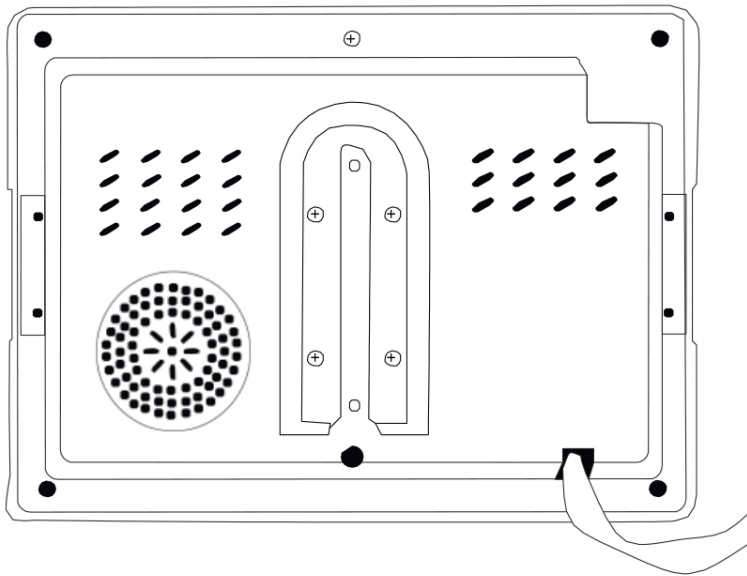
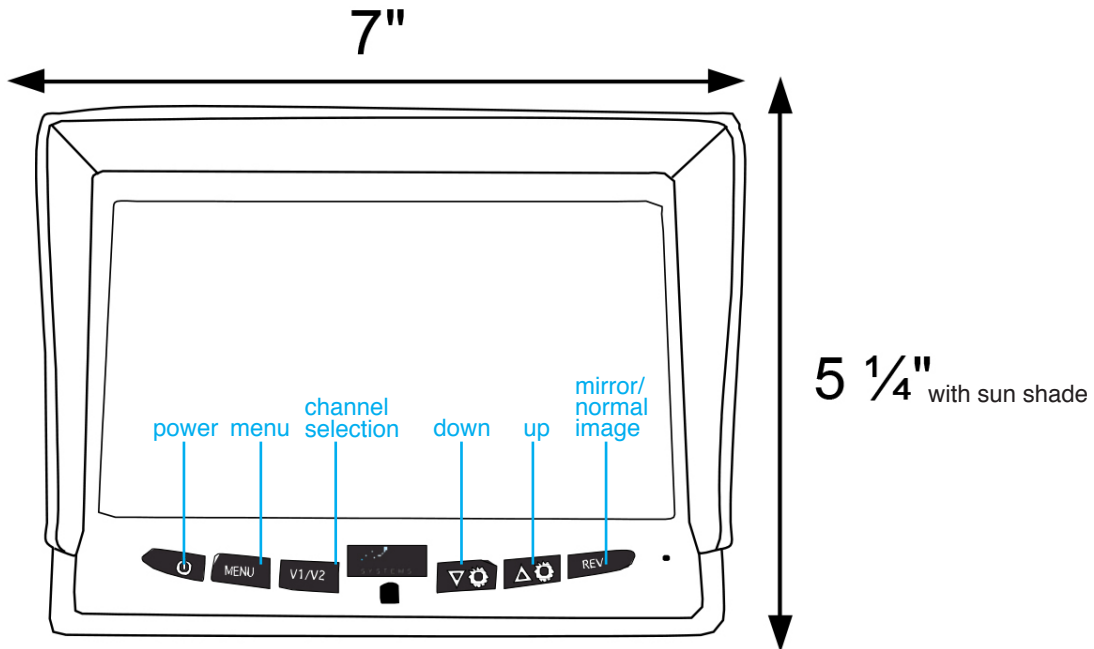

# camera dimensions

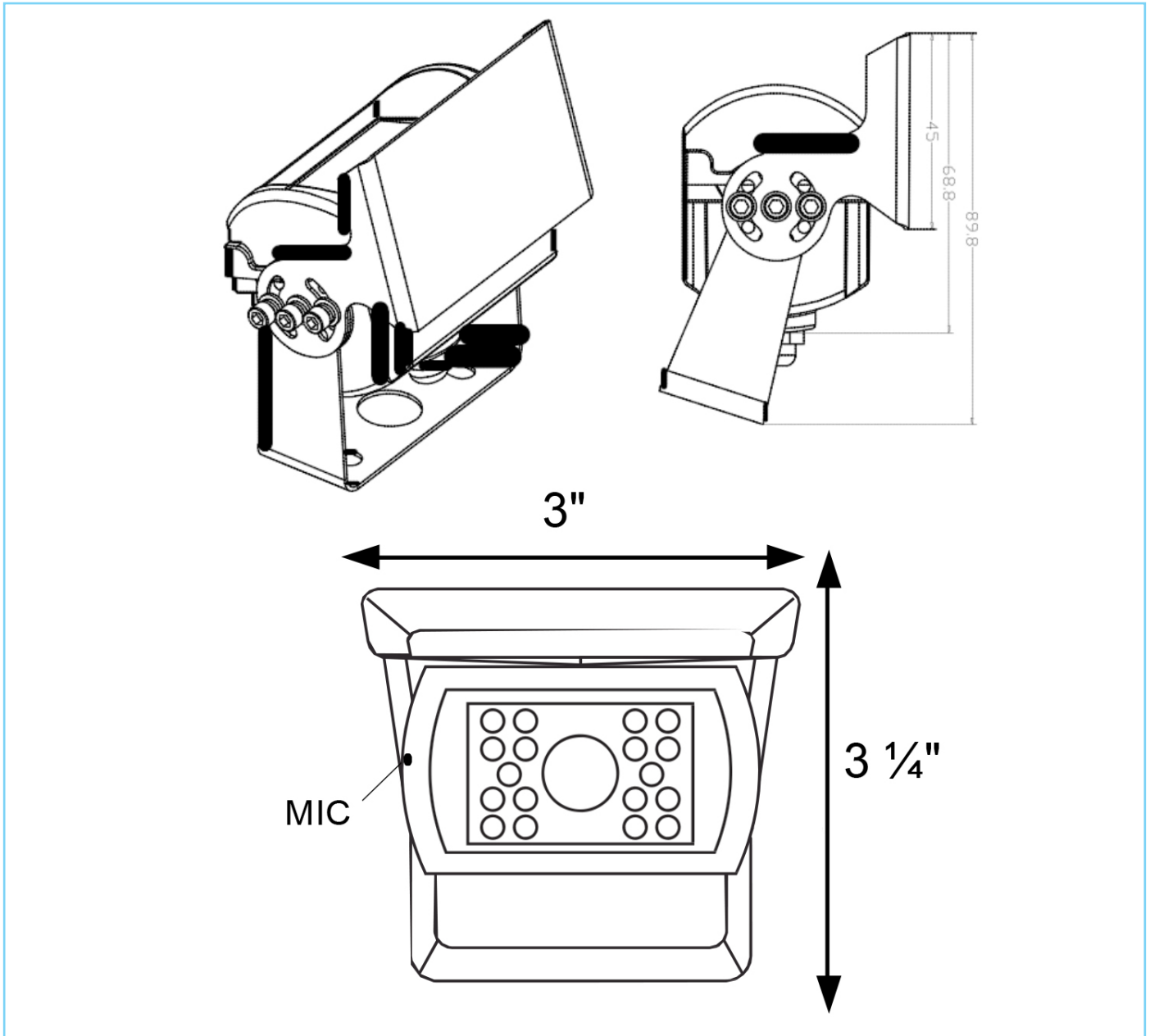

# camera specs.

Camera	1/4 Sharp® Color CCD
▶ Picture Elements	250,000 pixels
▶ Gamma Correction	r=0.45 to 1.0
▶ Image Sensor	480TV lines
▶ Lens	2.1mm
▶ View Angle	130°
▶ Sync System	Internal Synchronization
▶ Infra-red distance	50 Feet (18 Infrared)
▶ Usable Illumination	0 Lux (IR On)
▶ Power Source	DC 12V-24V (+/- 10%)
▶ S/N Ratio	More than 48dB
▶ Electronic Iris	1/50, 160-1/100,000sec
▶ Video Output	1Vp.p 75ohm
▶ IR Switch Control	CDS Automatic Control
▶ Impact / Shock Rating	20G Vibration / 100G Shock
▶ Operating Temperature	-30°C - 70°C / RH 95% Max
▶ Storage Temperature	-30°C - 70°C / RH 95% Max
▶ Waterproof Rating	IP68K



# monitor specs.

TFT LCD Digital Monitor	
▶ Screen Size	7"
▶ Dot Resolution	800 X 3 (RGB) X480
▶ Display Format	16:9 / 500:1
▶ Display Brightness	400cd/m <sup>2</sup>
▶ Viewing Angle	U:50/D:60 L/R:70
▶ Video Input	3 channel
▶ Video Source	1Vp-p, 75Ω
▶ Power Supply	DC 12V-24V(+/-10%)
▶ Power Consumption	5W
▶ Operating Temperature	30°C ~ +80° C
▶ Video System	Auto NTSC/PAL
▶ Overall Dimensions	7" (L) x 5" (H) x 1" (D)
▶ Weight	400G
▶ Impact Rating	5G
▶ DOT PITCH	0.192 ( H)X 0.1805 ( V )
▶ Sync System	Internal
▶ Monitor Weight	520g

# splitting & installing the embedded monitor

## Installing

Installing sun shield: put shade cover on the display. Installing back cover: Put the monitor with shade cover in the back cover (only for embedded monitor)

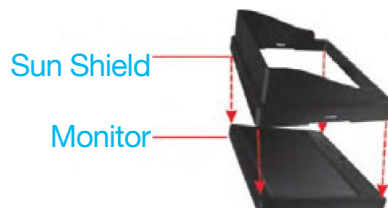

## Splitting

Splitting back cover: hold monitor with two hands, and detach by fingers as indicated by the arrow (only for embedded monitor, see below)



Splitting sun shield: Take the monitor on the left hand detach by right hand as indicated by the white arrow (see below )



# troubleshooting

## Monitor displays Blue screen & displays No Signal

- Do a hard reset, unplug all cables and power cables from multiplexer (silver box) leave out for 1 minute and then re-connect them.
- Check to ensure that the connection to the camera is tight.
- Verify camera cable is plugged into port labeled “Backup Camera”.
- Verify that the blue positive trigger on power harness is put to power 12v+  
*If the problem still persists, verify that alternate ports work. If alternate ports do not work, remove Blue Trigger wire from 12V+ and select alternate channels.*

## Monitor will not power up (no backlight on power button)

- Check fuse
- Check 12v+ to monitor
- Check ground connection

## No image on screen

- Verify camera is on correct camera input
- Verify cable is connected to monitor
- Verify camera is connected to cable
- Connect known working camera and cable to monitor.
- Verify Blue trigger is receiving power.
- If image appears, connect cable to existing camera
- If image remains, replace original cable
- If image disappears, replace original camera

## Monitor will not power up (no backlight on power button)

- Verify selected camera has audio
- Verify volume setting
- Confirm that the Blue audio trigger is connected to 12v+

# 1 Year Warranty

**RVS Systems warrants this product against material defects for a period of one year from date of purchase. We reserve the right to repair or replace any such defective unit at our sole discretion. RVS Systems is not responsible for a defect in the system as a result of misuse, improper installation, damage or mis-handling of the electronic components. RVS Systems is not responsible for consequential damages of any kind.**

This warranty is void if: defects in materials or workmanship or damages result from repairs or alterations which have been made or attempted by others or the unauthorized use of nonconforming parts; the damage is due to normal wear and tear, this damage is due to abuse, improper maintenance, neglect or accident; or the damage is due to use of the RVS System after partial failure or use with improper accessories.

## **WARRANTY PERFORMANCE**

DURING THE ABOVE WARRANTY PERIOD, SHOULD YOUR RVS SYSTEMS PRODUCT EXHIBIT A DEFECT IN MATERIAL OR WORKMANSHIP, SUCH DEFECT WILL BE REPAIRED WHEN THE COMPLETE RVS SYSTEMS PRODUCT IS RETURNED, POSTAGE PREPAID AND INSURED, TO RVS SYSTEMS. OTHER THAN THE POSTAGE AND INSURANCE REQUIREMENT, NO CHARGE WILL BE MADE FOR REPAIRS COVERED BY THIS WARRANTY.

## **WARRANTY DISCLAIMERS**

NO WARRANTY, ORAL OR WRITTEN, EXPRESSED OR IMPLIED, OTHER THE ABOVE WARRANTY IS MADE WITH REGARD TO THIS RVS SYSTEMS. RVS SYSTEMS DISCLAIMS ANY IMPLIED WARRANTY OR MERCHANTABILITY OR FITNESS FOR A PARTICULAR USE OR PURPOSE AND ALL OTHER WARRANTIES. IN NO EVENT SHALL RVS SYSTEMS BE LIABLE FOR ANY INCIDENTAL, SPECIAL, CONSEQUENTIAL, OR PUNITIVE DAMAGES OR FOR ANY COSTS, ATTORNEY FEES, EXPENSES, LOSSES OR DELAYS ALLEGED TO BE AS A CONSEQUENCE OF ANY DAMAGE TO, FAILURE OF, OR DEFECT IN ANY PRODUCT INCLUDING, BUT NOT LIMITED TO, ANY CLAIMS FOR LOSS OF PROFITS. IN SOME JURISDICTIONS, IT IS UNLAWFUL FOR A PERSON TO DRIVE A MOTOR VEHICLE EQUIPPED WITH A TV VIEWER OR SCREEN LOCATED FORWARD OF THE BACK OF THE DRIVER'S SEAT OR IN ANY LOCATION THAT IS VISIBLE, DIRECTLY OR INDIRECTLY, TO THE DRIVER WHILE OPERATING THE VEHICLE.



1680 Atlantic Ave #301  
Brooklyn NY 11213  
888-881-2601  
[www.rvssystems.com](http://www.rvssystems.com)